



Странична резачка за електротехници
DIN ISO 5749



76 01 125
Полирана глава, еднокомпонентни ръкохватки



76 03 125
Хромирана челюст, еднокомпонентни ръкохватки



76 05 125
Хромирана челюст, двукомпонентни ръкохватки



76 12 125

Полирана глава, двукомпонентни ръкохватки



76 22 125

Полирана глава, двукомпонентни ръкохватки







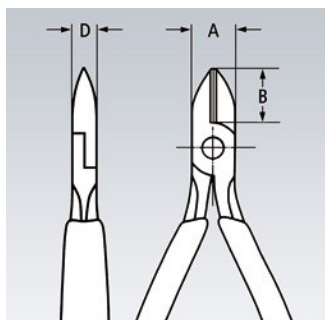

76 81 125

Полирана глава, едноконпонентни ръкохватки, остра глава



- [Описание](#)
- [Технически чертеж](#)
- с остри, точно шлифовани резци за мека и твърда тел, както и струни за пиано
- допълнително индуктивно закалени резци, твърдост на резците около 63 HRC
- сглобен шарнир
- Ванадиева електростомана, изковани, закалени в масло



Артикулен номер	EAN 4003773-					A mm	B mm	D mm	 mm	 g
		Ø mm	Ø mm	Ø mm	Ø mm					
76 01 125	018490	0,4 - 3,0	2,30	1,50	0,60	14,50	16,00	9,00	125	90
76 03 125	018506	0,4 - 2,5	1,80	1,00	0,60	14,50	16,00	9,00	125	90
76 05 125	005315	0,4 - 2,5	1,80	1,00	0,60	14,50	16,00	9,00	125	118
76 12 125	048015	0,4 - 2,5	1,80	1,00	0,60	14,50	16,00	9,00	125	112
76 22 125	048022	0,4 - 2,5				14,50	16,00	9,00	125	107
76 81 125	018544	0,4 - 1,7	1,30	0,80		14,50	16,00	9,00	125	87

Запазено право за технически изменения и несъответствия

Ташев-Галвинг ООД
www.tashev-galving.com